

300 WATTS

CE-300 SERIES AC-DC





FEATURES:

- RoHS Compliant
- Universal 85-264 VAC Input
- Compact 4.9" x 8.5" x 1.95 Size
- 2 Year Warranty
- One to Five Tightly Regulated Outputs
- EN 60950-1 ITE Certification
- Class B Emissions per EN 55022
- Harmonic Current per EN 61000-3-2
- EMC to EN 61000-6-2 and EN 60601-1-2



FAN/COVER

SAFETY SPECIFICATIONS

General	Protection Class: I Overvoltage Category: II Pollution Degree: 2
	Underwriters Laboratories File E137708/E140259 UL 60950-1 2 nd Edition, 2007
	CB Certificate per IEC 60950-1:2005 2 nd Edition +A1:2009 including all National Deviations
	UL Recognition Mark for Canada File E137708/E140259 CAN/CSA-C22.2 No. 60950-1-07, 2 nd Edition
	TUV EN 60950-1/A12:2011
	Low Voltage Directive (2006/95/EC of December 2006) RoHS Directive (Recast) (2011/65/EU of June 2011)

MODEL LISTING

MODEL NO.	OUTPUT 1	OUTPUT 2	OUTPUT 3	OUTPUT 4	OUTPUT 5
CE-300-5001	+5V/40A	+24V/4A	+12V/6A	-5V/1A	-12V/2A
CE-300-5002	+5V/40A	+12V/8A	-12V/6A	-5V/1A	+24V/2A
CE-300-5003	+5V/40A	+12V/8A	+24V/3A	-15V/1A	+15V/2A
CE-300-5004	+5V/40A	+24V/4A	24V/3A	-12V/1A	+12V/2A
CE-300-5005	+24V/8A	+12V/8A	+5V/6A	-15V/1A	+15V/2A
CE-300-5006	+24V/8A	24V/4A	+5V/6A	-15V/1A	+15V/2A
CE-300-5012	+5V/40A	+28V/3A	+12V/6A	-5V/2A	-12V/2A
CE-300-5013	+5V/40A	+3.3V/6A	+24V/4A	-5V/1A	12V/2A
CE-300-4001	+5V/40A	+12V/8A	-5V/5A		-12V/2A
CE-300-4002	+5V/40A	+24V/4A	+12V/6A		-12V/2A
CE-300-4003	+5V/40A	+24V/4A	+15V/4A		-15V/2A
CE-300-4004	+24V/8A	+12V/8A	+5V/6A		-12V/2A
CE-300-4005	+5V/40A	-5.2V/12A	+12V/6A		-12V/2A
CE-300-4006	+24V/8A	+12V/8A		-12V/1.5A	5V/2A
CE-300-4007	+24V/8A	+15V/6A	+5V/6A		-15V/2A
CE-300-4009	+24V/8A	+12V/8A	+5V/10A		-12V/2A
CE-300-4011	+5V/40A	+3.3/12A		+12V/2A	-12V/2A
CE-300-3001	+5V/40A	+12V/8A	-12V/6A		
CE-300-3002	+5V/40A	+12V/8A	+24V/3A		
CE-300-3003	+5V/40A	+15V/6A	-15V/4A		
CE-300-3004	+12V/16A	+12V/8A	+5V/6A		
CE-300-3006	+5V/40A	+3.3/12A		+12V/2A	
CE-300-2001	+5V/40A	+24V/4A			
CE-300-2002	+12V/16A	-12V/8A			
CE-300-2003	+15V/13A	-15V/6A			
CE-300-2004	+24V/8A	-24V/4A			
CE-300-1001	5V/60A				
CE-300-1002	12V/25A				
CE-300-1003	15V/20A				
CE-300-1004	24V/12A				

OUTPUT SPECIFICATIONS

Total Output Power	300W
Output Voltage Centering	Outputs 1 – 5: ± 0.5% (All outputs at 50% load)
Output Voltage Adjust Range	Outputs 1 – 3: 95 - 105%
Load Regulation	Outputs 1 – 5: 1.0% (10-100% load change)
Source Regulation	Outputs 1 – 5: 0.5%
Cross Regulation	Outputs 2 – 5: 0.5% (Output 1 load varied 50-100%)
Output Noise	Outputs 1 - 5: 1.0%
Turn on Overshoot	None
Transient Response	Outputs 1 – 5
Voltage Deviation	5.0%
Recovery Time	2mS
Load Change	50% to 100%
Output Overvoltage Protection (Optional)	Output 1: 120% to 150% Shuts down all outputs. Cycle input to restart.
Output Overpower Protection	340 W Min., Outputs cycle on/off, auto recovery
Output Overcurrent Protection	Outputs 2,3,4 & 5, 110% Min
Hold Up Time	20 mS min., 300W Output, 120V Input
Start Up Time	3 Seconds

INPUT SPECIFICATIONS

Source Voltage	85 – 264 Volts AC
Frequency Range	47 – 63 Hz
Source Current	
True RMS	5.8A at 85V Input
Peak Inrush	20A
Peak Repetitive	8.2A at 85V Input
Harmonic Distortion	0.05
Efficiency	.68-.80(Varies by model)
Power Factor	0.90 (300 W, 230V)

ENVIRONMENTAL SPECIFICATIONS

Ambient Operating	0° C to +50° C
Temperature Range	Derating: See Power Rating Chart
Ambient Storage Temp. Range	-40° C to +85° C
Temperature Coefficient	Outputs 1 – 5: 0.02%/°C

GENERAL SPECIFICATIONS

Dielectric Strength ⁽⁸⁾	
Reinforced Insulation	4242 VDC, Primary to Secondary, 1 Sec.
Basic Insulation	2121 VDC, Primary to Ground, 1 Sec.
Operational Insulation	500 VDC, Secondary to Ground, 1 Sec.
Power Fail Signal	Logic low with input power failure 2 mS minimum prior to Output 1 dropping 1%
Remote On/Off (optional)	Contact closure shuts off all outputs
Remote Sense(outputs 1 & 2)	250mV compensation of output cable losses
Weight	3.30 Lbs.

ELECTROMAGNETIC COMPATIBILITY SPECIFICATIONS

Electrostatic Discharge	EN 61000-4-2 +/- 8kV Contact Discharge +/- 8kV Air Discharge
Radiated Electromagnetic Field	EN 61000-4-3 80MHz-2.5GHz, 10/m, 80% AM
EFT/Bursts	EN 61000-4-4 +/- 2 kV
Surges	EN 61000-4-5 +/- 1 kV Differential Mode +/- 2 kV Common Mode
Conducted Immunity	EN 61000-4-6 .15 to 80MHz, 3V, 80% AM
Voltage Dips and Interruptions	EN 61000-4-11 30% Reduction, 500ms 95% Reduction, 10ms 60% Reduction, 1s (Criteria B) 95% Reductions, 5000ms
Radiated Emissions	EN 55022 Class B
Conducted Emissions	EN 55022 Class B
Harmonic Current Emissions	EN 61000-3-2

NOTES

Consult factory for alternate output configurations.
Consult factory for positive, negative or floating outputs.
Refer to Applications Information for complete output power ratings.
All specifications are maximum at 25° C, 300W unless otherwise stated, may vary by model and are subject to change without notice.
Specify optional power fail, overvoltage protection or remote on/off when ordering.

CE-300 SERIES MECHANICAL SPECIFICATIONS

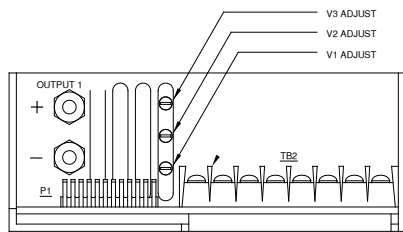
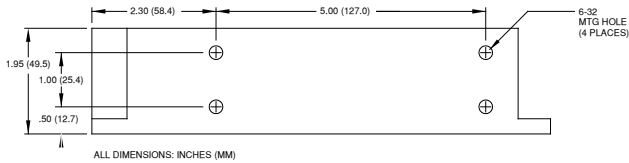
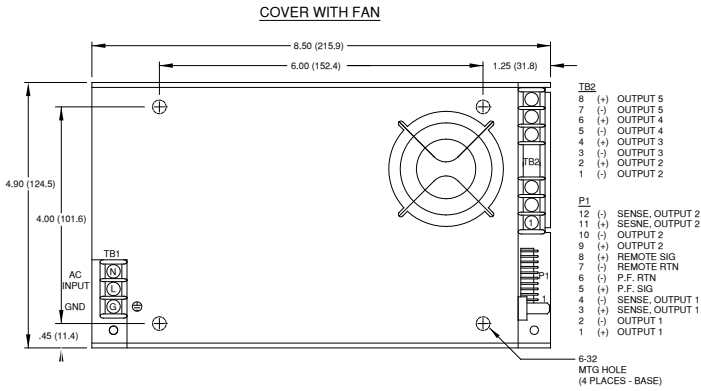

APPLICATIONS INFORMATION

- Semiconductor case temperatures must not exceed 110°C.
- Each output can deliver its rated current but total output power must not exceed 300 watts.
- Internal fan provides airflow to cool internal components. Area around fan and vent openings must be kept clear to allow unrestricted airflow in and out of these openings. This product is intended for use as a professionally installed component within information technology.
- A minimum load of 10% is required on output one to ensure proper regulation of remaining outputs.
- Remote sense terminals may be used to compensate for cable losses up to 250mV. The use of a twisted pair is recommended as well as a decoupling capacitor (0.1 - 10μF) and a capacitor of 100μF/amp connected across the load side.
- Peak to peak output ripple and noise is measured directly at the output terminals of the power supply, without the use of the probe ground lead or retractable tip, 20 MHz bandwidth.
- This product was type tested and safety certified using the dielectric strength test voltages listed in Table 5B of UL 60950-1. In consideration of Clause 5.2.2, care must be taken to insure that the voltage applied to a reinforced insulation does not overstress basic insulation. Secondary to ground capacitors may need to be removed prior to performing a dielectric strength type test on the end product. It is highly recommended that the DC equivalent test voltages be used when performing a production-line dielectric strength test of the assembled end product. Please consult factory before performing an AC dielectric strength test.
- This power supply has been safety approved and final tested using a DC dielectric strength test. Please consult factory before performing an AC dielectric strength test.
- Maximum screw penetration into chassis mounting holes is .188 inches.

MAXIMUM OUTPUT POWER VS. AMBIENT TEMPERATURE

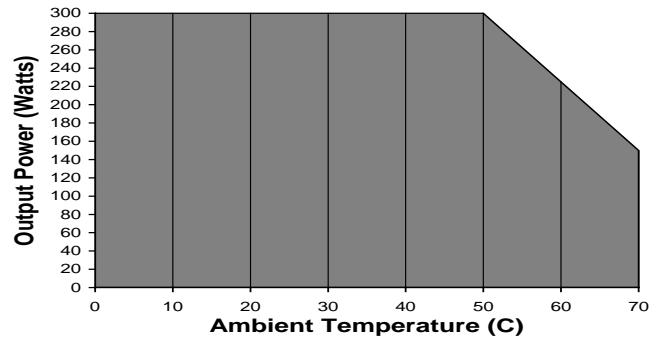

CONNECTOR SPECIFICATIONS

TB1	AC Input	Terminal block with 6-32 screws on 0.325 centers mates with #6, 0.26 inch wide spade terminals. (10 in-lb max)
TB2	DC Output	Terminal block with 6-32 screws on 0.325 centers mates with #6, 0.26 inch wide spade terminals. (10 in-lb max)
+ / -	DC Output	10-32 threaded studs mate with #10 ring tongue terminals.
P1	Option/Sense	.100 breakaway header mates with Molex 22-01-2127 or equivalent crimp terminal housing with Molex 6459 or equivalent crimp terminal.